



# ACOUSTIC SHELLS



 SHI-CHI

**Symphony Shell**  
**Portable Acoustic Shell**

## SC SHI Symphony Shell

### Section A – General

1. Shell panels feature stress-skin honeycomb composite or optional foam core construction.
2. Various finishes are available by owner's representative from standard Formica laminate.
3. Ceiling panels hang from rigging and store vertically in the fly loft.
4. Feature pre-set angle to ensure precise alignment when moved into performance position.
5. Panels come pre-wired with power strips while light fixture opening can be integrated into the panels according to owner's needs.
6. Moveable towers and rows of ceiling panels form a full stage acoustic enclosure when placed together on stage.
7. Access panel removes easily and provides approach for Transporter.
8. Convenient, quiet stage access doors make it fast and easy to move people on and off stage.
9. The two lower wing panels on each modular tower are hinged to become doorways, as needed.
10. Adjustable bases and pads make it easy to level towers.
11. Wing lock device is easy locking tower wings and requires on tools.
12. The transporter forks nest securely around the tower frame.
13. The counterweighted base provides shells stability when towers are set in place and when they are moved from performance to storage areas.
14. Provide custom panel radius, shape, mass and density to meet specific acoustic requirements.
15. Patented designs.

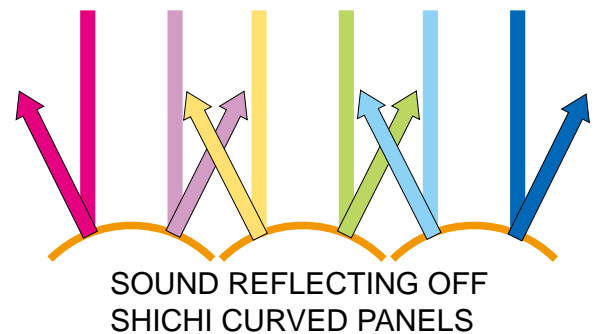
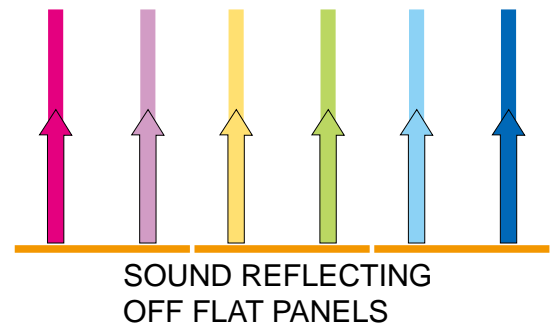

The curved surface shell reflects and diffuses sound in all directions to generate fuller, richer and resonance tones. Musicians hear themselves and each other better, and the audience receives a vibrant, more accurate sound mix from the performance.

A flat surfaced wall can't achieve well-balanced sound. When sound strikes a flat surface, it directly reflects back to its source.



Front View-Performance Position

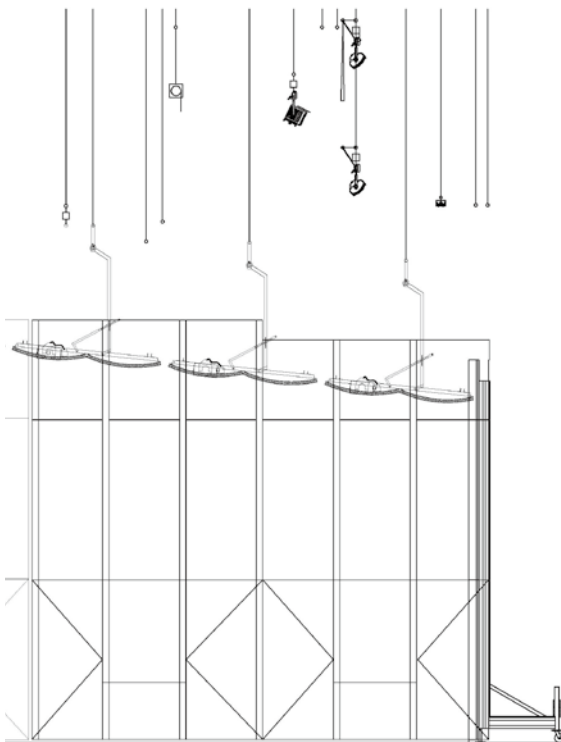

Side View  
Manual Rotation

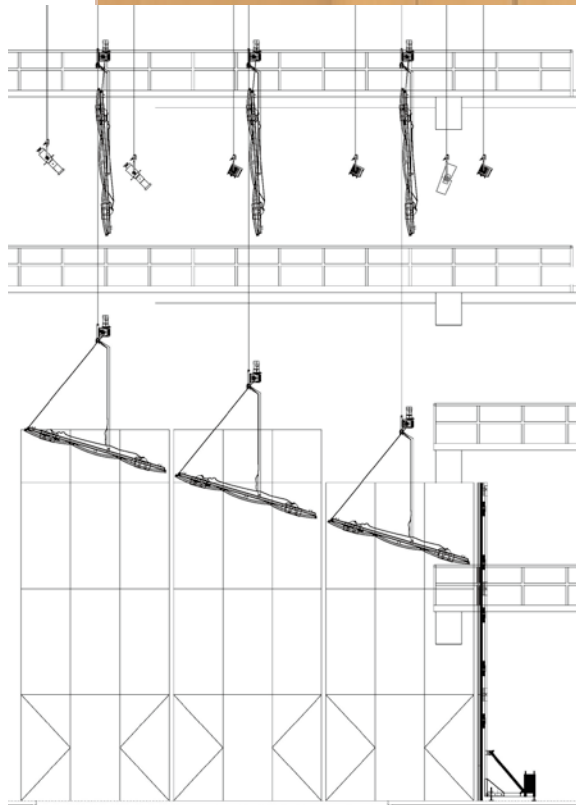

Automatic Rotation

# ACOUSTIC SHELLS



# ACOUSTIC SHELLS

## Section B – Specifications

### 1. Shell panels

#### 1.1 External Formica Laminate:

1.1.1 Thickness: 1/32"~1/16"

1.1.2 Fire Rating: Class B or Class 1

1.1.3 Finish: Various options from Formica Laminate

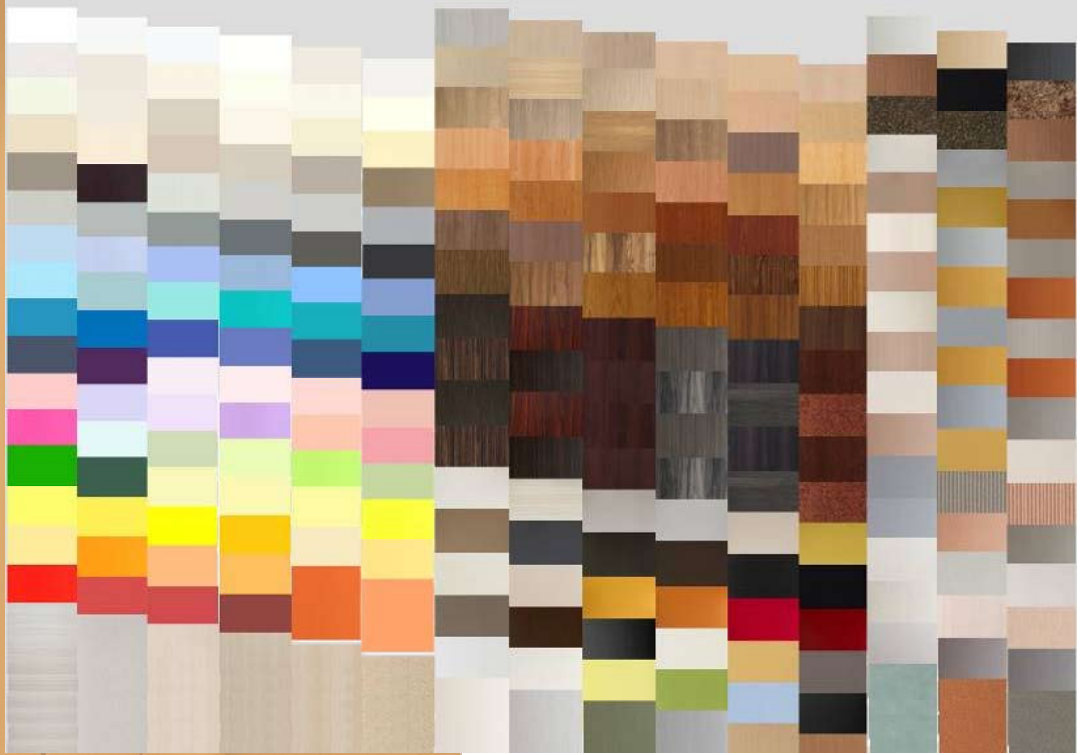

#### 1.4 Baking Plywood:

1.4.1 Thickness: 1/8"

1.4.2 Fire Rating: Class B or Class 1

1.4.3 Color: Black



#### 1.5 Frame:

1.5.1 Material: In-lade Aluminum extrusion

1.5.2 Color: Black anodized

1.6 Weight: No less than 2 1/2 lb/sq ft (not include frame)

#### 1.7 Others:

1.7.1 Radius: 6'



Radius: 6'



- 1.7.2 No fasteners are exposed in face.
- 1.7.3 High-solid pressure cured urethane structural adhesive.

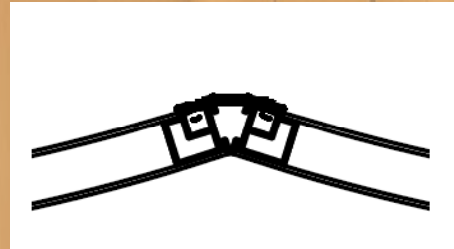
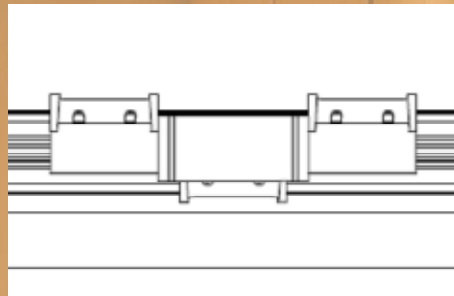
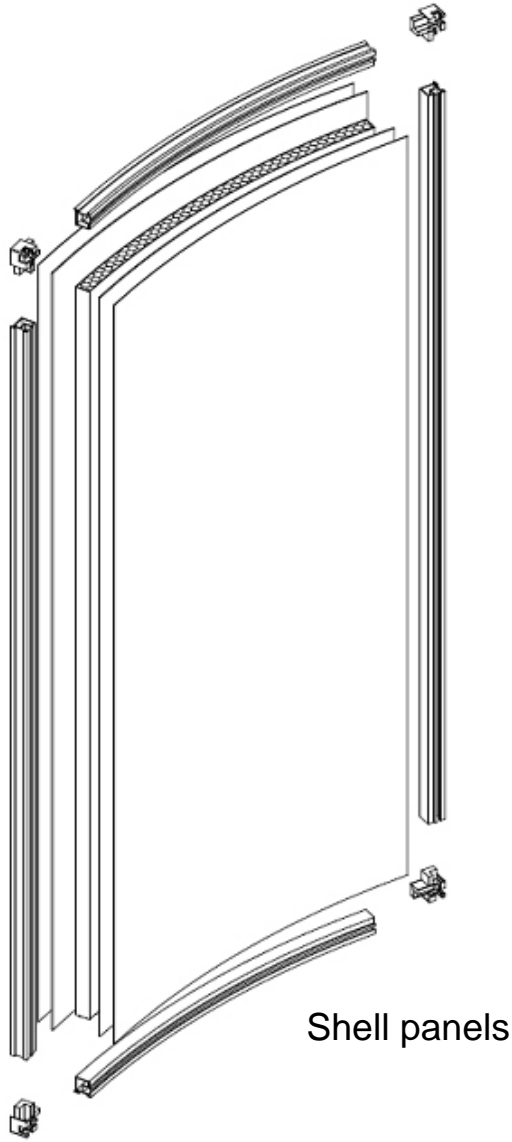

In-lade Aluminum extrusion

# ACOUSTIC SHELLS

# ACOUSTIC SHELLS

## 2. Ceiling

2.1 Ceiling panels store in a vertical position, and rotate to pre-set, adjustable performance angle.

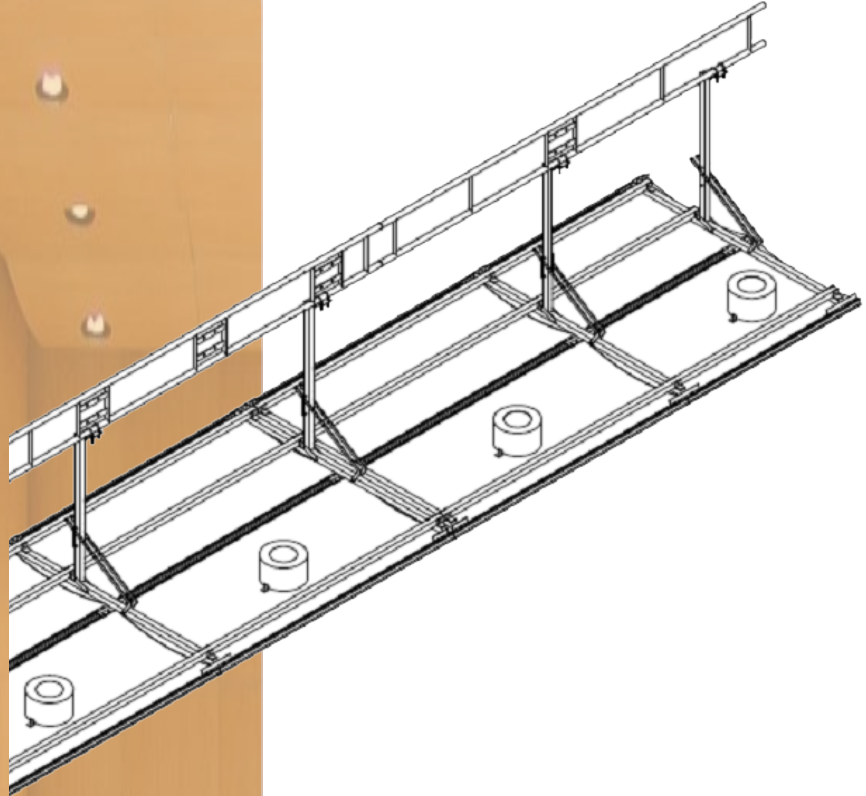

2.2 Adjustable angles in 10° increments from 0° to 90° without tools.

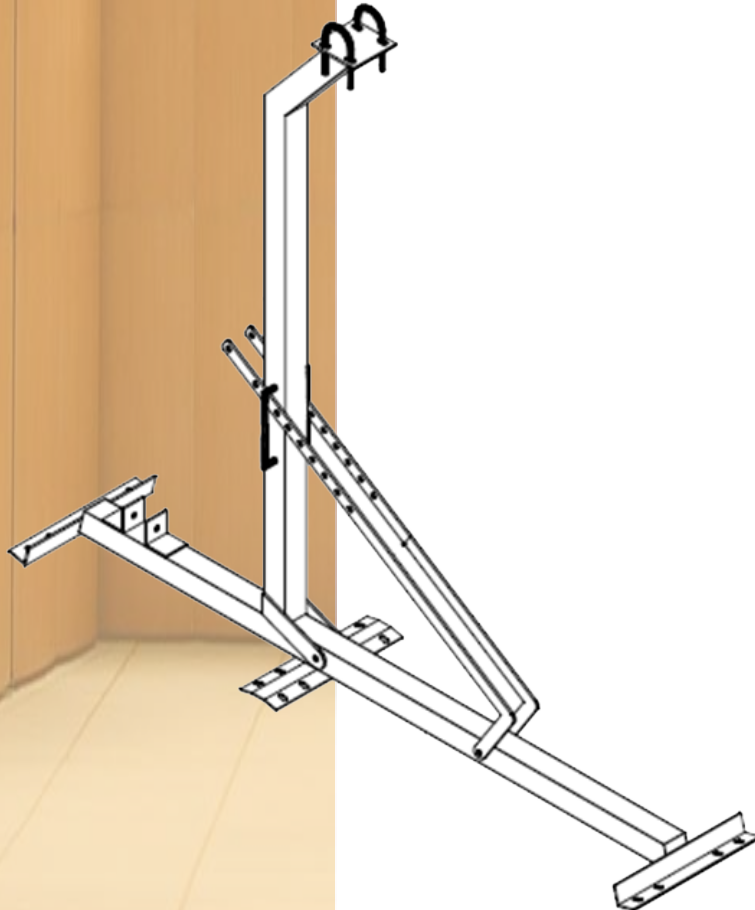

# ACOUSTIC SHELLS

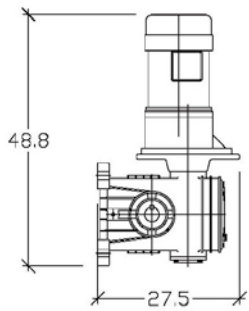
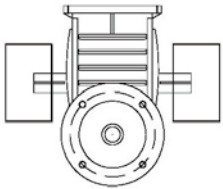
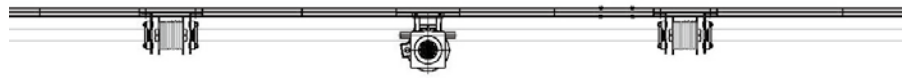
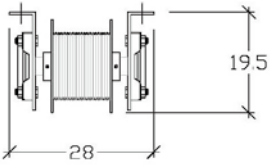
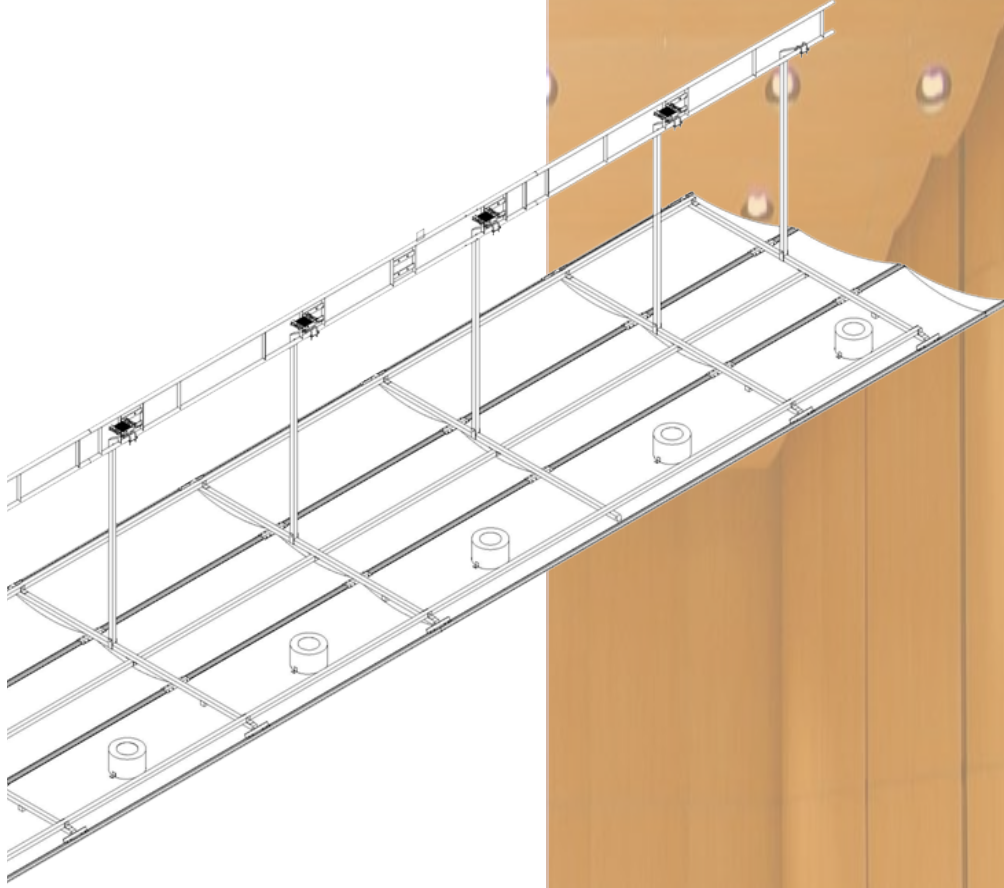



# ACOUSTIC SHELLS



2.4 Lighting Fixture:ETC Par MCM, 575W

2.3 Ceiling storage profile can be as little as 13 1/2”.

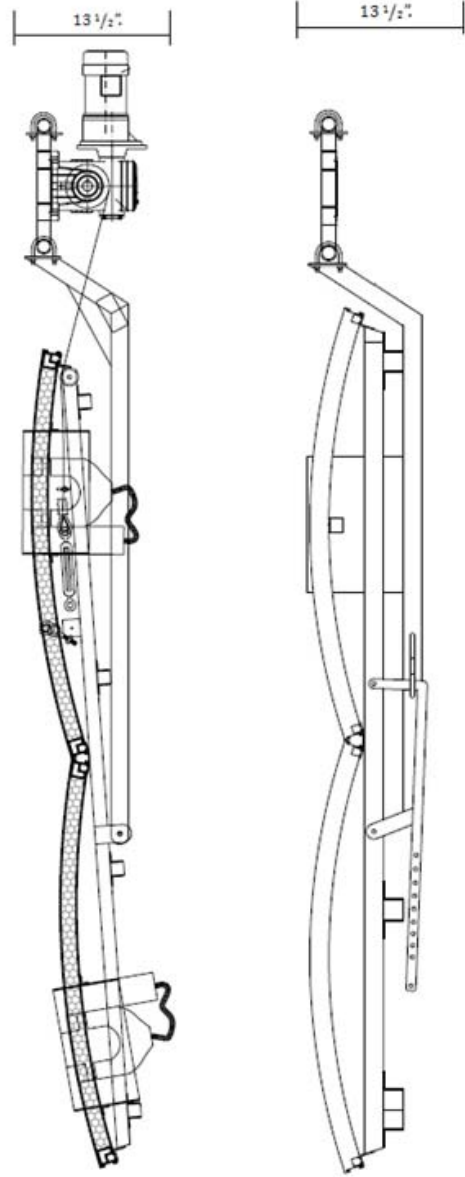

3. Tower

3.1 Each tower consists of one center panel and two adjustable wing panels



3.2 Each panel is equipped with a counterweighted base assembly for stability.

3.3 Each tower incorporates leveling adjustment mechanisms.



# ACOUSTIC SHELLS

3.4 Double doors allow access of large equipment.



3.5 A telescoping wing lock device locks tower wings in performance or storage positions.



3.6 Towers nest together to minimize storage space.

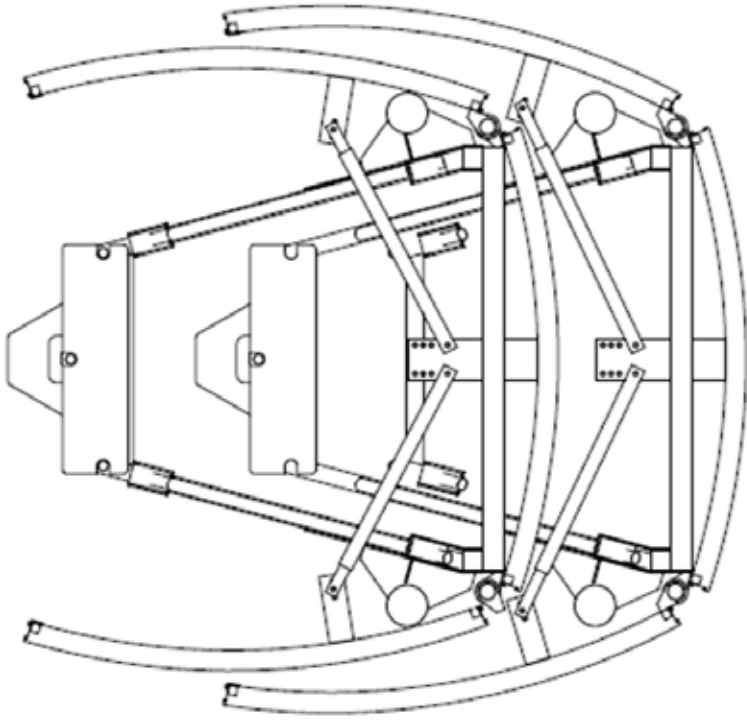

# ACOUSTIC SHELLS

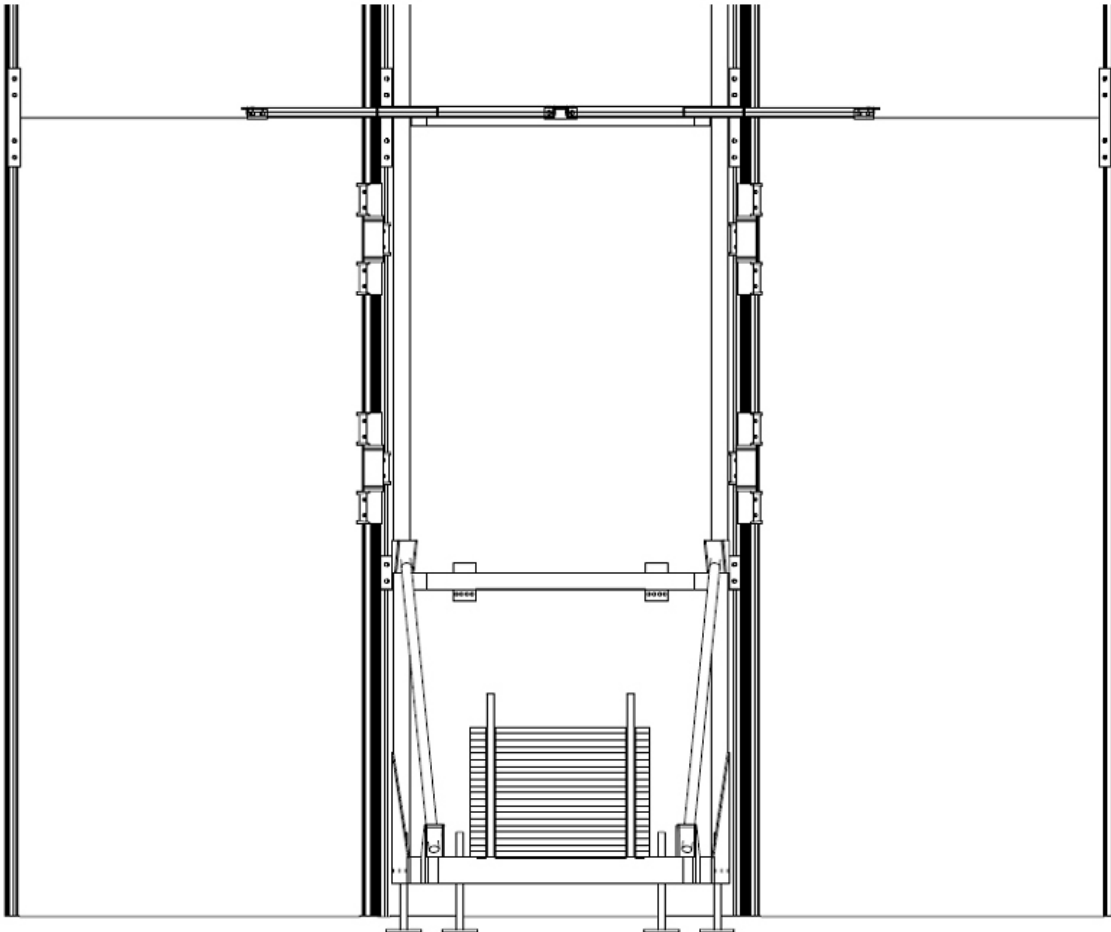



# ACOUSTIC SHELLS

- 4. Transport
- 4.1 Lift Power options:
- 4.1.1 Rechargeable Battery

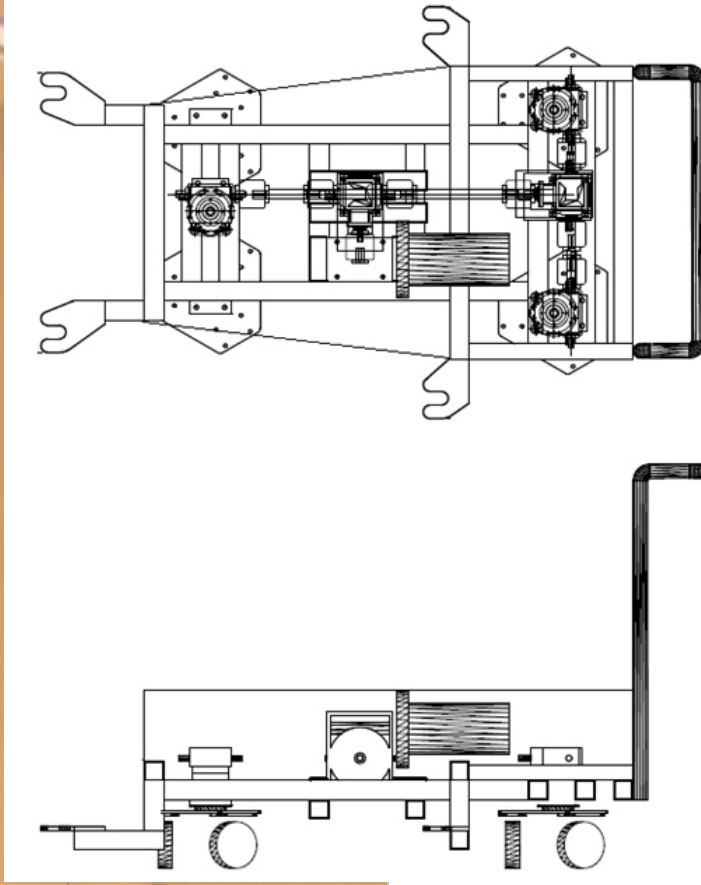

- 4.1.2 Hydraulic

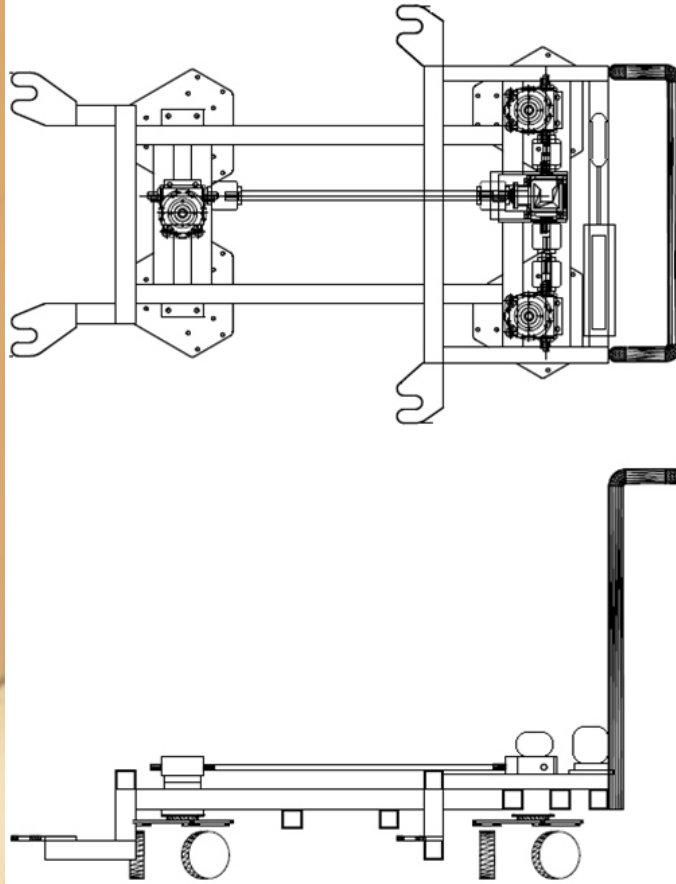



## 4.2 Caster Options:

4.2.1 With three 4" diameter dual wheel casters, load capacity per caster is 2,000 lb.

4.2.2 With five 2 1/2" diameter dual wheel casters, load capacity per caster is 2,000 lb.

## 4.3 Frame: 2" steel tubular



## 5. Standards:

5.1 ASTM E-90, STC 23db

5.2 ASTM C-423, NRC 0.10, SAA 0.09

## ACOUSTIC SHELLS



## Portable Acoustic Shell

Shi-Chi's Portable Acoustic Shell system is a flexible and portable sound shell. The shells create enhanced sound and professional atmosphere to make every performance memorable. A better sound rewards both performers and audience with superior blend, mix and projection. The shell finishes ABS surface.

Shells are ideal for use in stages, rehearsal and classrooms. The design can be operated by single person with no tools for saving set-up and take-down time. Panels are folding small enough to pass through standard doorways. The rigid honeycomb construction enhanced superior sound quality. Shells stack compactly in storage. The rigid honeycomb construction enhanced superior sound quality. Shells stack compactly in storage.



- Panels are folding small enough to pass through standard doorways.



Shi-Chi Convexo-Concave Shell provides well-balanced sound.



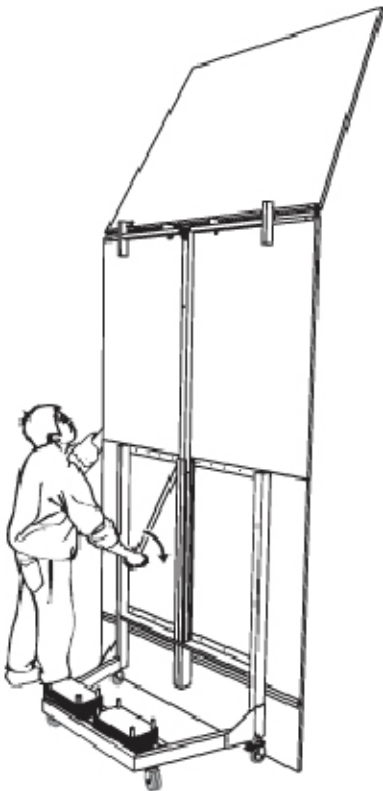
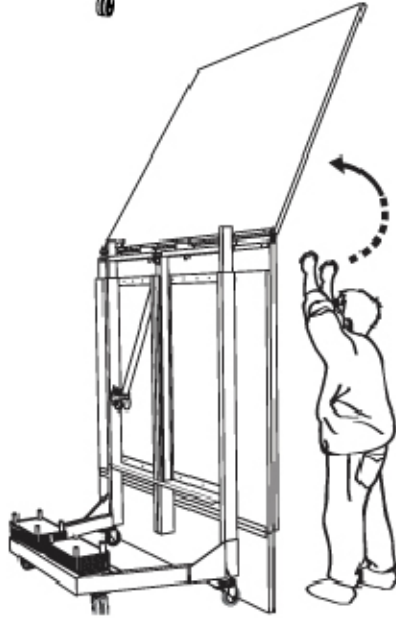
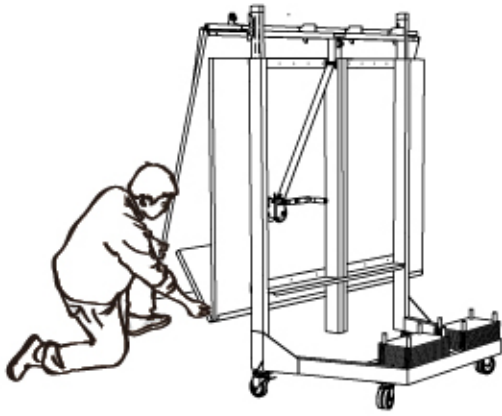

- The shells can be positioned and setup by one person with on tools in minutes.



- Top panel adjustable unlimited or in 15° increments from 45°, 60°, 75° to 90°.



- Angle Setting



- Removable Handle



- Shells move smoothly with heavy-duty polyurethane swivel casters to give noise and vibration free.

# ACOUSTIC SHELLS

# ACOUSTIC SHELLS

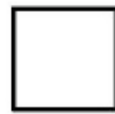
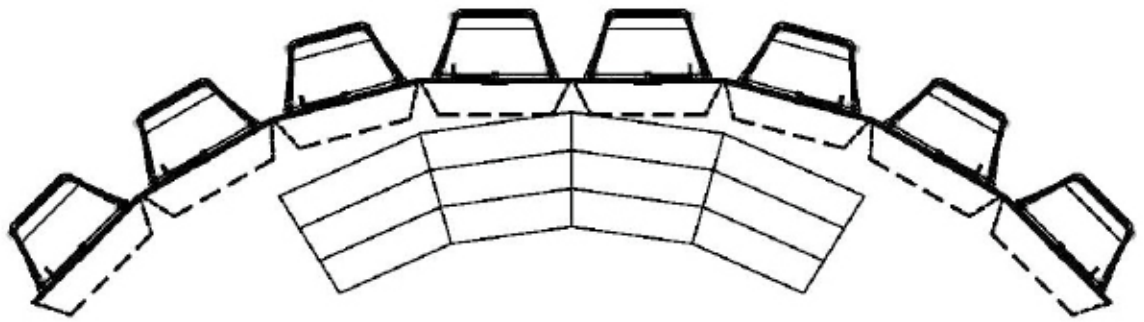

- Chorus Type: Portable Acoustic Shells with Choral Risers

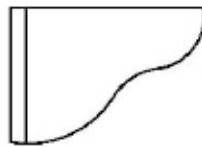
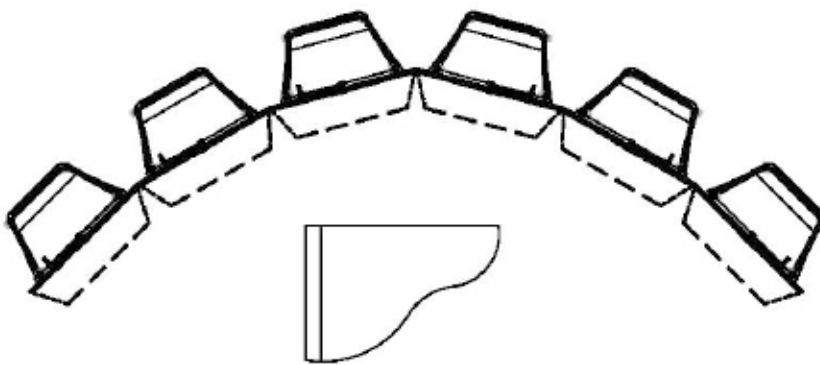

- Concert Type: Portable Acoustic Shells



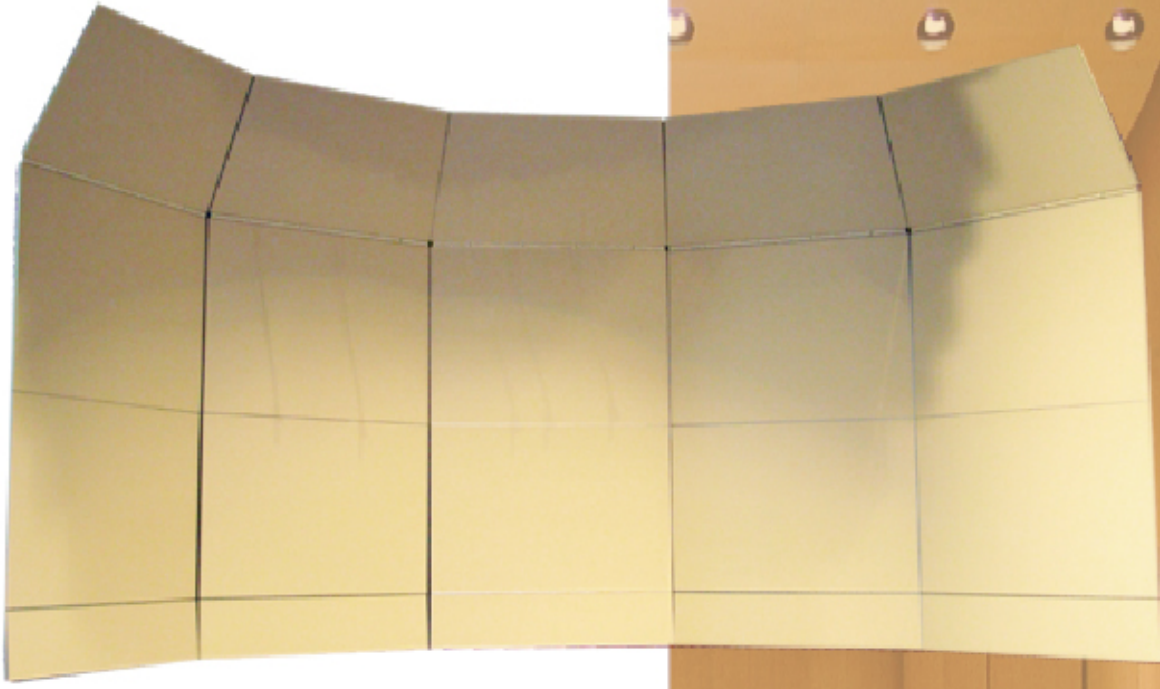

## ACOUSTIC SHELLS